



University of British Columbia
 CPSC 314 Computer Graphics
 Jan-Apr 2013

Tamara Munzner

Math Review
guest lecture: James Gregson

Week 1, Wed Jan 2

<http://www.ugrad.cs.ubc.ca/~cs314/Vjan2013>

News

- usual lecture order switched
 - math review today (Jan 2)
 - James Gregson, TA
 - usually second lecture
 - course intro and overview Friday (Jan 4)
 - Tamara Munzner, instructor
 - usually first lecture

Notation: Scalars, Vectors, Matrices

- scalar
 - (lower case, italic)
- vector
 - (lower case, bold)
- matrix
 - (upper case, bold)

a

$$\mathbf{a} = [a_1 \quad a_2 \quad \dots \quad a_n]$$

$$\mathbf{A} = \begin{bmatrix} a_{11} & a_{12} & a_{13} \\ a_{21} & a_{22} & a_{23} \\ a_{31} & a_{32} & a_{33} \end{bmatrix}$$

Vectors

- arrow: length and direction
 - oriented segment in nD space
- offset / displacement
 - location if given origin

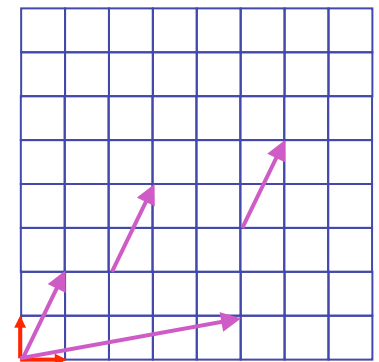

Column vs. Row Vectors

• row vectors $\mathbf{a}_{row} = [a_1 \ a_2 \ \dots \ a_n]$

• column vectors $\mathbf{a}_{col} = \begin{bmatrix} a_1 \\ a_2 \\ \dots \\ a_n \end{bmatrix}$

• switch back and forth with transpose

$$\mathbf{a}_{col}^T = \mathbf{a}_{row}$$

5

Vector-Vector Addition

- add: vector + vector = vector
- parallelogram rule
 - tail to head, complete the triangle

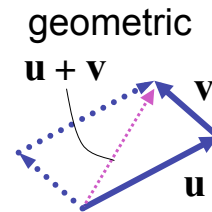

algebraic

$$\mathbf{u} + \mathbf{v} = \begin{bmatrix} u_1 + v_1 \\ u_2 + v_2 \\ u_3 + v_3 \end{bmatrix}$$

examples: $(3,2) + (6,4) = (9,6)$
 $(2,5,1) + (3,1,-1) = (5,6,0)$

6

Vector-Vector Subtraction

- subtract: vector - vector = vector

$$\mathbf{u} - \mathbf{v} = \begin{bmatrix} u_1 - v_1 \\ u_2 - v_2 \\ u_3 - v_3 \end{bmatrix}$$

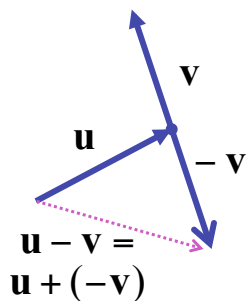

$(3,2) - (6,4) = (-3,-2)$
 $(2,5,1) - (3,1,-1) = (-1,4,2)$

7

Vector-Vector Subtraction

- subtract: vector - vector = vector

$$\mathbf{u} - \mathbf{v} = \begin{bmatrix} u_1 - v_1 \\ u_2 - v_2 \\ u_3 - v_3 \end{bmatrix}$$

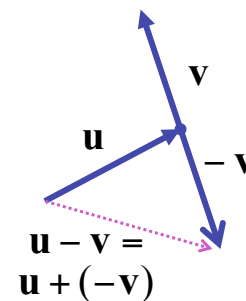

$(3,2) - (6,4) = (-3,-2)$
 $(2,5,1) - (3,1,-1) = (-1,4,2)$

argument reversal

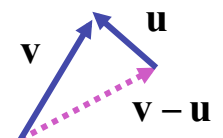
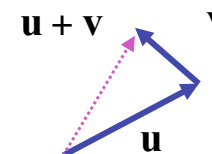

8

Scalar-Vector Multiplication

- multiply: scalar * vector = vector
 - vector is scaled

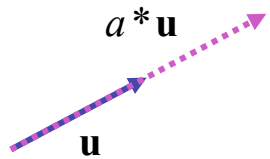

$$a * \mathbf{u} = (a * u_1, a * u_2, a * u_3)$$

$$2 * (3, 2) = (6, 4)$$

$$.5 * (2, 5, 1) = (1, 2.5, .5)$$

9

Vector-Vector Multiplication

- multiply: vector * vector = scalar
- dot product, aka inner product

$$\mathbf{u} \cdot \mathbf{v}$$

$$\begin{bmatrix} u_1 \\ u_2 \\ u_3 \end{bmatrix} \cdot \begin{bmatrix} v_1 \\ v_2 \\ v_3 \end{bmatrix} = (u_1 * v_1) + (u_2 * v_2) + (u_3 * v_3)$$

10

Vector-Vector Multiplication

- multiply: vector * vector = scalar
- dot product, aka inner product

$$\mathbf{u} \cdot \mathbf{v}$$

u_1	v_1
u_2	v_2
u_3	v_3

$$= (u_1 * v_1) + (u_2 * v_2) + (u_3 * v_3)$$

11

Vector-Vector Multiplication

- multiply: vector * vector = scalar
- dot product, aka inner product

$$\mathbf{u} \cdot \mathbf{v}$$

$$\begin{bmatrix} u_1 \\ u_2 \\ u_3 \end{bmatrix} \cdot \begin{bmatrix} v_1 \\ v_2 \\ v_3 \end{bmatrix} = (u_1 * v_1) + (u_2 * v_2) + (u_3 * v_3)$$

$$\mathbf{u} \cdot \mathbf{v} = \|\mathbf{u}\| \|\mathbf{v}\| \cos \theta$$

- geometric interpretation
 - lengths, angles
 - can find angle between two vectors

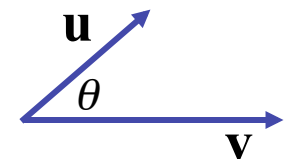

12

Dot Product Geometry

- can find length of projection of u onto v

$$\mathbf{u} \cdot \mathbf{v} = \|\mathbf{u}\| \|\mathbf{v}\| \cos \theta$$

$$\|\mathbf{u}\| \cos \theta = \frac{\mathbf{u} \cdot \mathbf{v}}{\|\mathbf{v}\|}$$

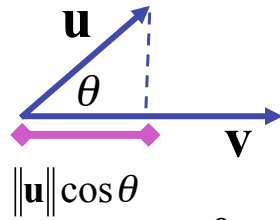

- as lines become perpendicular, $\mathbf{u} \cdot \mathbf{v} \rightarrow 0$

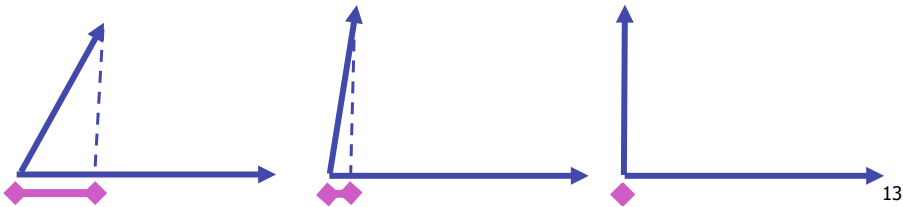

13

Dot Product Example

$$\begin{bmatrix} u_1 \\ u_2 \\ u_3 \end{bmatrix} \cdot \begin{bmatrix} v_1 \\ v_2 \\ v_3 \end{bmatrix} = (u_1 * v_1) + (u_2 * v_2) + (u_3 * v_3)$$

$$\begin{bmatrix} 6 \\ 1 \\ 2 \end{bmatrix} \cdot \begin{bmatrix} 1 \\ 7 \\ 3 \end{bmatrix} = (6 * 1) + (1 * 7) + (2 * 3) = 6 + 7 + 6 = 19$$

14

Vector-Vector Multiplication, The Sequel

- multiply: vector * vector = vector
- cross product
 - algebraic

$$\begin{bmatrix} u_1 \\ u_2 \\ u_3 \end{bmatrix} \times \begin{bmatrix} v_1 \\ v_2 \\ v_3 \end{bmatrix} = \begin{bmatrix} u_2 v_3 - u_3 v_2 \\ u_3 v_1 - u_1 v_3 \\ u_1 v_2 - u_2 v_1 \end{bmatrix}$$

15

Vector-Vector Multiplication, The Sequel

- multiply: vector * vector = vector
- cross product
 - algebraic

$$\begin{bmatrix} u_1 \\ u_2 \\ u_3 \end{bmatrix} \times \begin{bmatrix} v_1 \\ v_2 \\ v_3 \end{bmatrix} = \begin{bmatrix} u_2 v_3 - u_3 v_2 \\ u_3 v_1 - u_1 v_3 \\ u_1 v_2 - u_2 v_1 \end{bmatrix}$$

16

Vector-Vector Multiplication, The Sequel

- multiply: vector * vector = vector
- cross product
 - algebraic

$$\begin{matrix} 3 \\ 1 \\ 2 \end{matrix} \begin{bmatrix} u_1 \\ u_2 \\ u_3 \end{bmatrix} \times \begin{bmatrix} v_1 \\ v_2 \\ v_3 \end{bmatrix} = \begin{bmatrix} u_2 v_3 - u_3 v_2 \\ u_3 v_1 - u_1 v_3 \\ u_1 v_2 - u_2 v_1 \end{bmatrix}$$

blah blah

17

Vector-Vector Multiplication, The Sequel

- multiply: vector * vector = vector
- cross product
 - algebraic
 - geometric

$$\begin{bmatrix} u_1 \\ u_2 \\ u_3 \end{bmatrix} \times \begin{bmatrix} v_1 \\ v_2 \\ v_3 \end{bmatrix} = \begin{bmatrix} u_2 v_3 - u_3 v_2 \\ u_3 v_1 - u_1 v_3 \\ u_1 v_2 - u_2 v_1 \end{bmatrix}$$

$$\|\mathbf{a} \times \mathbf{b}\| = \|\mathbf{a}\| \|\mathbf{b}\| \sin \theta$$

- $\|\mathbf{a} \times \mathbf{b}\|$ parallelogram area
- $\mathbf{a} \times \mathbf{b}$ perpendicular to parallelogram

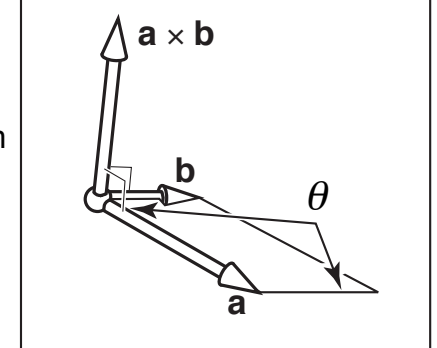

18

RHS vs. LHS Coordinate Systems

- right-handed coordinate system **convention**

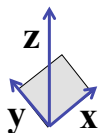

right hand rule:
index finger x, second finger y;
right thumb points up
 $\mathbf{z} = \mathbf{x} \times \mathbf{y}$

- left-handed coordinate system

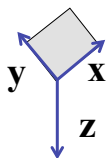

left hand rule:
index finger x, second finger y;
left thumb points down
 $\mathbf{z} = \mathbf{x} \times \mathbf{y}$

19

Basis Vectors

- take any two vectors that are **linearly independent** (nonzero and nonparallel)
 - can use linear combination of these to define any other vector:

$$\mathbf{c} = w_1 \mathbf{a} + w_2 \mathbf{b}$$

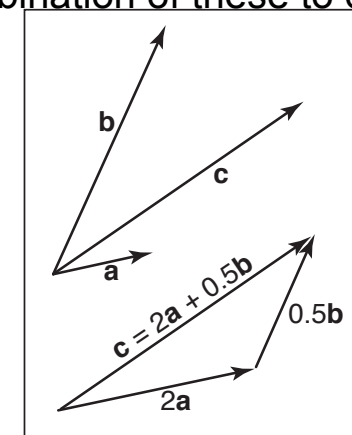

20

Orthonormal Basis Vectors

- if basis vectors are **orthonormal** (**orthogonal** (mutually perpendicular) and unit length)
 - we have Cartesian coordinate system
 - familiar Pythagorean definition of distance

orthonormal algebraic properties

$$\|x\| = \|y\| = 1,$$

$$x \cdot y = 0$$

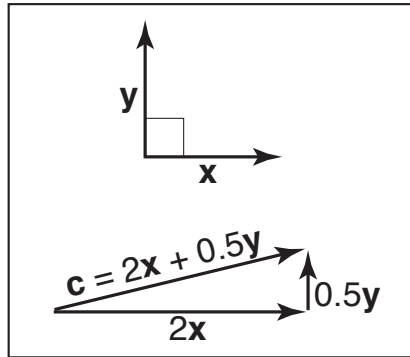

21

Basis Vectors and Origins

- **coordinate system**: just basis vectors
 - can only specify offset: vectors
- **coordinate frame**: basis vectors and origin
 - can specify location as well as offset: points

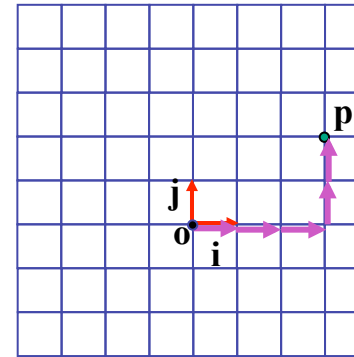

$$p = o + xi + yj$$

22

Working with Frames

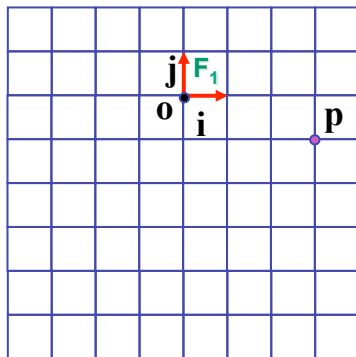

$$p = o + xi + yj$$

F_1

23

Working with Frames

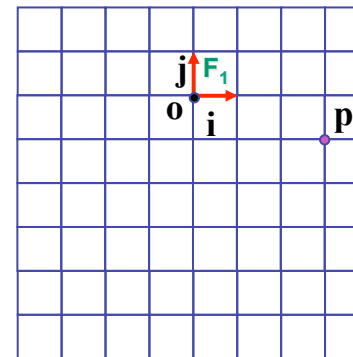

$$p = o + xi + yj$$

F_1 $p = (3, -1)$

24

Working with Frames

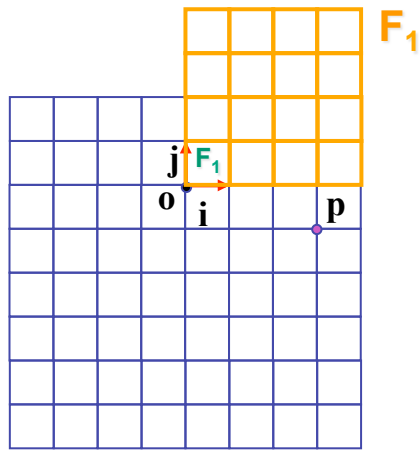

$$\mathbf{p} = \mathbf{o} + x\mathbf{i} + y\mathbf{j}$$

$$\mathbf{F}_1 \quad \mathbf{p} = (3, -1)$$

25

Working with Frames

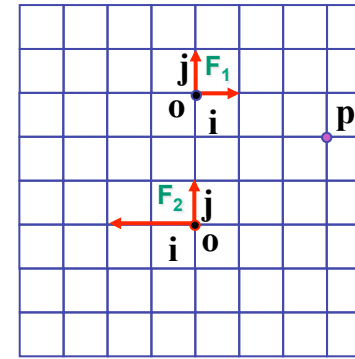

$$\mathbf{p} = \mathbf{o} + x\mathbf{i} + y\mathbf{j}$$

$$\mathbf{F}_1 \quad \mathbf{p} = (3, -1)$$

$$\mathbf{F}_2$$

26

Working with Frames

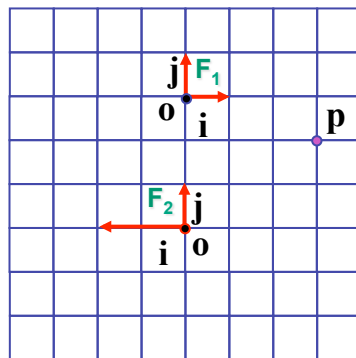

$$\mathbf{p} = \mathbf{o} + x\mathbf{i} + y\mathbf{j}$$

$$\mathbf{F}_1 \quad \mathbf{p} = (3, -1)$$

$$\mathbf{F}_2 \quad \mathbf{p} = (-1.5, 2)$$

27

Working with Frames

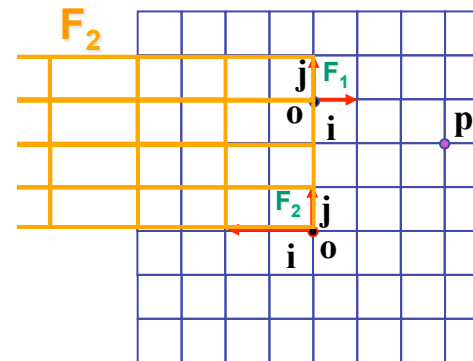

$$\mathbf{p} = \mathbf{o} + x\mathbf{i} + y\mathbf{j}$$

$$\mathbf{F}_1 \quad \mathbf{p} = (3, -1)$$

$$\mathbf{F}_2 \quad \mathbf{p} = (-1.5, 2)$$

28

Working with Frames

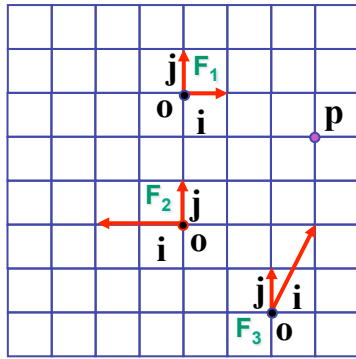

$$\mathbf{p} = \mathbf{o} + x\mathbf{i} + y\mathbf{j}$$

$$\mathbf{F}_1 \quad \mathbf{p} = (3, -1)$$

$$\mathbf{F}_2 \quad \mathbf{p} = (-1.5, 2)$$

$$\mathbf{F}_3$$

29

Working with Frames

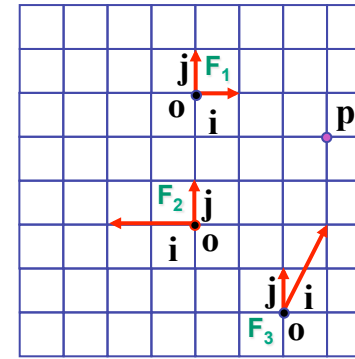

$$\mathbf{p} = \mathbf{o} + x\mathbf{i} + y\mathbf{j}$$

$$\mathbf{F}_1 \quad \mathbf{p} = (3, -1)$$

$$\mathbf{F}_2 \quad \mathbf{p} = (-1.5, 2)$$

$$\mathbf{F}_3 \quad \mathbf{p} = (1, 2)$$

30

Working with Frames

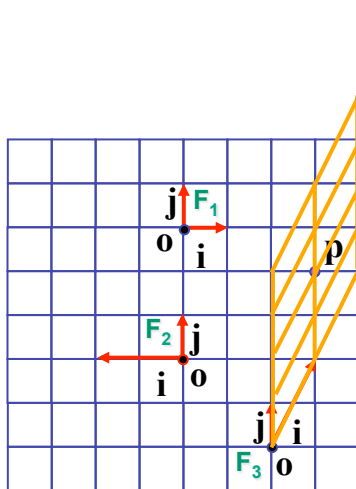

$$\mathbf{F}_3$$

$$\mathbf{p} = \mathbf{o} + x\mathbf{i} + y\mathbf{j}$$

$$\mathbf{F}_1 \quad \mathbf{p} = (3, -1)$$

$$\mathbf{F}_2 \quad \mathbf{p} = (-1.5, 2)$$

$$\mathbf{F}_3 \quad \mathbf{p} = (1, 2)$$

31

Named Coordinate Frames

- origin and basis vectors $\mathbf{p} = \mathbf{o} + ax + by + cz$
- pick canonical frame of reference
 - then don't have to store origin, basis vectors
 - just $\mathbf{p} = (a, b, c)$
 - convention: Cartesian orthonormal one on previous slide
- handy to specify others as needed
 - airplane nose, looking over your shoulder, ...
 - really common ones given names in CG
 - object, world, camera, screen, ...

32

Lines

- slope-intercept form
 - $y = mx + b$
- implicit form
 - $y - mx - b = 0$
 - $Ax + By + C = 0$
 - $f(x,y) = 0$

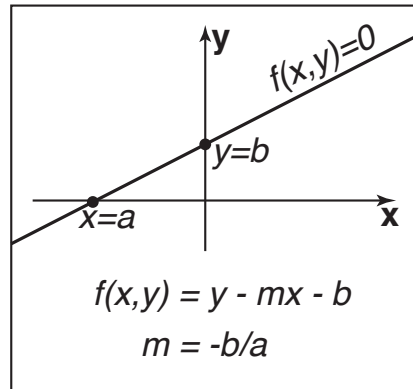

33

Implicit Functions

- find where function is 0
 - plug in (x,y) , check if
 - 0: on line
 - < 0 : inside
 - > 0 : outside
- analogy: terrain
 - sea level: $f=0$
 - altitude: function value
 - topo map: equal-value contours (level sets)

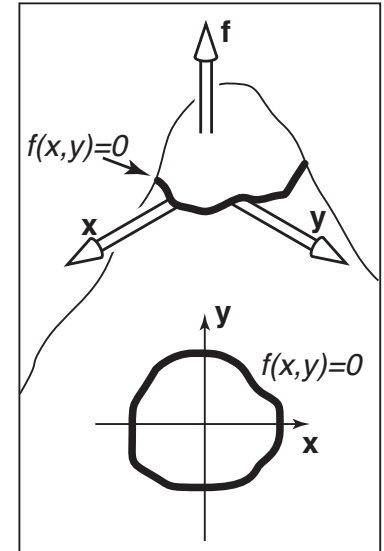

34

Implicit Circles

- $f(x,y) = (x - x_c)^2 + (y - y_c)^2 - r^2$
 - circle is points (x,y) where $f(x,y) = 0$
- $p = (x,y), c = (x_c, y_c) : (\mathbf{p} - \mathbf{c}) \cdot (\mathbf{p} - \mathbf{c}) - r^2 = 0$
 - points \mathbf{p} on circle have property that vector from \mathbf{c} to \mathbf{p} dotted with itself has value r^2
- $\|\mathbf{p} - \mathbf{c}\|^2 - r^2 = 0$
 - points \mathbf{p} on the circle have property that squared distance from \mathbf{c} to \mathbf{p} is r^2
- $\|\mathbf{p} - \mathbf{c}\| - r = 0$
 - points \mathbf{p} on circle are those a distance r from center point \mathbf{c}

35

Parametric Curves

- parameter: index that changes continuously
 - (x,y) : point on curve
 - t : parameter
- vector form
 - $\mathbf{p} = f(t)$

$$\begin{bmatrix} x \\ y \end{bmatrix} = \begin{bmatrix} g(t) \\ h(t) \end{bmatrix}$$

36

2D Parametric Lines

- $$\begin{bmatrix} x \\ y \end{bmatrix} = \begin{bmatrix} x_0 + t(x_1 - x_0) \\ y_0 + t(y_1 - y_0) \end{bmatrix}$$
- $\mathbf{p}(t) = \mathbf{p}_0 + t(\mathbf{p}_1 - \mathbf{p}_0)$
- $\mathbf{p}(t) = \mathbf{o} + t(\mathbf{d})$
- start at point \mathbf{p}_0 , go towards \mathbf{p}_1 , according to parameter t
 - $\mathbf{p}(0) = \mathbf{p}_0, \mathbf{p}(1) = \mathbf{p}_1$

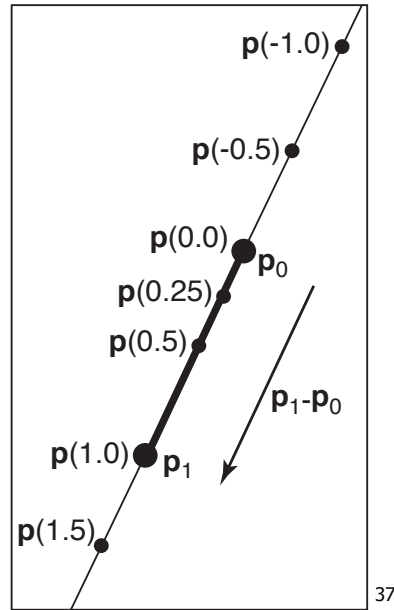

Linear Interpolation

- parametric line is example of general concept
 - $\mathbf{p}(t) = \mathbf{p}_0 + t(\mathbf{p}_1 - \mathbf{p}_0)$
 - interpolation
 - \mathbf{p} goes through \mathbf{a} at $t = 0$
 - \mathbf{p} goes through \mathbf{b} at $t = 1$
 - linear
 - weights $t, (1-t)$ are linear polynomials in t

38

Matrix-Matrix Addition

- add: matrix + matrix = matrix

$$\begin{bmatrix} m_{11} & m_{12} \\ m_{21} & m_{22} \end{bmatrix} + \begin{bmatrix} n_{11} & n_{12} \\ n_{21} & n_{22} \end{bmatrix} = \begin{bmatrix} n_{11} + m_{11} & n_{12} + m_{12} \\ n_{21} + m_{21} & n_{22} + m_{22} \end{bmatrix}$$

- example

$$\begin{bmatrix} 1 & 3 \\ 2 & 4 \end{bmatrix} + \begin{bmatrix} -2 & 5 \\ 7 & 1 \end{bmatrix} = \begin{bmatrix} 1+(-2) & 3+5 \\ 2+7 & 4+1 \end{bmatrix} = \begin{bmatrix} -1 & 8 \\ 9 & 5 \end{bmatrix}$$

39

Scalar-Matrix Multiplication

- multiply: scalar * matrix = matrix

$$a \begin{bmatrix} m_{11} & m_{12} \\ m_{21} & m_{22} \end{bmatrix} = \begin{bmatrix} a * m_{11} & a * m_{12} \\ a * m_{21} & a * m_{22} \end{bmatrix}$$

- example

$$3 \begin{bmatrix} 2 & 4 \\ 1 & 5 \end{bmatrix} = \begin{bmatrix} 3*2 & 3*4 \\ 3*1 & 3*5 \end{bmatrix} = \begin{bmatrix} 6 & 12 \\ 3 & 15 \end{bmatrix}$$

40

Matrix-Matrix Multiplication

- can only multiply (n,k) by (k,m):
number of left cols = number of right rows

- legal

$$\begin{bmatrix} a & b & c \\ e & f & g \end{bmatrix} \begin{bmatrix} h & i \\ j & k \\ l & m \end{bmatrix}$$

- undefined

$$\begin{bmatrix} a & b & c \\ e & f & g \\ o & p & q \end{bmatrix} \begin{bmatrix} h & i \\ j & k \end{bmatrix}$$

41

Matrix-Matrix Multiplication

- row by column

$$\begin{bmatrix} m_{11} & m_{12} \\ m_{21} & m_{22} \end{bmatrix} \begin{bmatrix} n_{11} & n_{12} \\ n_{21} & n_{22} \end{bmatrix} = \begin{bmatrix} p_{11} & p_{12} \\ p_{21} & p_{22} \end{bmatrix}$$

$$p_{11} = m_{11}n_{11} + m_{12}n_{21}$$

42

Matrix-Matrix Multiplication

- row by column

$$\begin{bmatrix} m_{11} & m_{12} \\ m_{21} & m_{22} \end{bmatrix} \begin{bmatrix} n_{11} & n_{12} \\ n_{21} & n_{22} \end{bmatrix} = \begin{bmatrix} p_{11} & p_{12} \\ p_{21} & p_{22} \end{bmatrix}$$

$$p_{11} = m_{11}n_{11} + m_{12}n_{21}$$

$$p_{21} = m_{21}n_{11} + m_{22}n_{21}$$

43

Matrix-Matrix Multiplication

- row by column

$$\begin{bmatrix} m_{11} & m_{12} \\ m_{21} & m_{22} \end{bmatrix} \begin{bmatrix} n_{11} & n_{12} \\ n_{21} & n_{22} \end{bmatrix} = \begin{bmatrix} p_{11} & p_{12} \\ p_{21} & p_{22} \end{bmatrix}$$

$$p_{11} = m_{11}n_{11} + m_{12}n_{21}$$

$$p_{21} = m_{21}n_{11} + m_{22}n_{21}$$

$$p_{12} = m_{11}n_{12} + m_{12}n_{22}$$

44

Matrix-Matrix Multiplication

- row by column

$$\begin{bmatrix} m_{11} & m_{12} \\ m_{21} & m_{22} \end{bmatrix} \begin{bmatrix} n_{11} & n_{12} \\ n_{21} & n_{22} \end{bmatrix} = \begin{bmatrix} p_{11} & p_{12} \\ p_{21} & p_{22} \end{bmatrix}$$

$$p_{11} = m_{11}n_{11} + m_{12}n_{21}$$

$$p_{21} = m_{21}n_{11} + m_{22}n_{21}$$

$$p_{12} = m_{11}n_{12} + m_{12}n_{22}$$

$$p_{22} = m_{21}n_{12} + m_{22}n_{22}$$

45

Matrix-Matrix Multiplication

- row by column

$$\begin{bmatrix} m_{11} & m_{12} \\ m_{21} & m_{22} \end{bmatrix} \begin{bmatrix} n_{11} & n_{12} \\ n_{21} & n_{22} \end{bmatrix} = \begin{bmatrix} p_{11} & p_{12} \\ p_{21} & p_{22} \end{bmatrix}$$

$$p_{11} = m_{11}n_{11} + m_{12}n_{21}$$

$$p_{21} = m_{21}n_{11} + m_{22}n_{21}$$

$$p_{12} = m_{11}n_{12} + m_{12}n_{22}$$

$$p_{22} = m_{21}n_{12} + m_{22}n_{22}$$

- noncommutative: **AB** \neq **BA**

46

Matrix-Vector Multiplication

- points as column vectors: postmultiply

$$\begin{bmatrix} x' \\ y' \\ z' \\ h' \end{bmatrix} = \begin{bmatrix} m_{11} & m_{12} & m_{13} & m_{14} \\ m_{21} & m_{22} & m_{23} & m_{24} \\ m_{31} & m_{32} & m_{33} & m_{34} \\ m_{41} & m_{42} & m_{43} & m_{44} \end{bmatrix} \begin{bmatrix} x \\ y \\ z \\ h \end{bmatrix} \quad \mathbf{p}' = \mathbf{M}\mathbf{p}$$

- points as row vectors: premultiply

$$[x' \ y' \ z' \ h'] = [x \ y \ z \ h] \begin{bmatrix} m_{11} & m_{12} & m_{13} & m_{14} \\ m_{21} & m_{22} & m_{23} & m_{24} \\ m_{31} & m_{32} & m_{33} & m_{34} \\ m_{41} & m_{42} & m_{43} & m_{44} \end{bmatrix}^T \quad \mathbf{p}'^T = \mathbf{p}^T \mathbf{M}^T$$

47

Matrices

- transpose $\begin{bmatrix} m_{11} & m_{12} & m_{13} & m_{14} \\ m_{21} & m_{22} & m_{23} & m_{24} \\ m_{31} & m_{32} & m_{33} & m_{34} \\ m_{41} & m_{42} & m_{43} & m_{44} \end{bmatrix}^T = \begin{bmatrix} m_{11} & m_{21} & m_{31} & m_{41} \\ m_{12} & m_{22} & m_{32} & m_{42} \\ m_{13} & m_{23} & m_{33} & m_{43} \\ m_{14} & m_{24} & m_{34} & m_{44} \end{bmatrix}$
- identity $\begin{bmatrix} 1 & 0 & 0 & 0 \\ 0 & 1 & 0 & 0 \\ 0 & 0 & 1 & 0 \\ 0 & 0 & 0 & 1 \end{bmatrix}$
- inverse $\mathbf{A}\mathbf{A}^{-1} = \mathbf{I}$
 - not all matrices are invertible

48

Matrices and Linear Systems

- linear system of n equations, n unknowns

$$3x + 7y + 2z = 4$$

$$2x - 4y - 3z = -1$$

$$5x + 2y + z = 1$$

- matrix form **$Ax=b$**

$$\begin{bmatrix} 3 & 7 & 2 \\ 2 & -4 & -3 \\ 5 & 2 & 1 \end{bmatrix} \begin{bmatrix} x \\ y \\ z \end{bmatrix} = \begin{bmatrix} 4 \\ -1 \\ 1 \end{bmatrix}$$

Readings For Lecture

- FCG Chapter 2: Miscellaneous Math
 - except 2.7 (2.11 in 2nd edition)
- FCG Chapter 5: Linear Algebra
 - except 5.4 (not in 2nd edition)